

# NGDP

POWER SUPPLY

## GOLD FULL-MODULAR



### Feature:

- Full Japanese Capacitors
- 80 PLUS Gold certified
- 0 RPM fan
- ATX 3.1 and PCIe 5.1 ready
- Test report download via MES ID

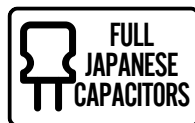

POWER SUPPLY  
NGDP

# SAFETY AND PROTECTION

Your new power supply unit comes equipped with multiple protective features to ensure safe and reliable operation:

**Under-Voltage Protection (UVP)** shuts the PSU off if the voltage the PSU is providing to the PC drops below accepted values.

**Over-Voltage Protection (OVP)** Monitors 12V, 5V, and 3.3V outputs. Automatically shuts down the PSU if voltage exceeds safe levels.

**Over-Power Protection (OPP)** Turns off the PSU if power draw reaches preset percentage of the rated capacity.

**Short-Circuit Protection (SCP)** Activates when output impedance falls below 0.1 ohms. Protects against shorts between rails or to ground, preventing damage to the PSU and system components.

**Over-Current Protection (OCP)** Keeps 3.3V, 5V, and 12V rail outputs within safe operating limits.

**Over-Temperature Protection (OTP)** Shuts down the PSU if internal temperature becomes too high, typically due to overloading or fan failure.

These safety mechanisms work together to protect your computer system and the power supply itself from potential electrical hazards. For optimal performance and longevity, always operate your PSU within its rated specifications.



**POWER SUPPLY  
NGDP GOLD**

# SPECIFICATIONS HA-750BA4

NGDP GOLD 750W

MODEL	HA-750BA4
POWER OUTPUT	750 W
INPUT VOLTAGE	100 - 240V
INPUT CURRENT	10 - 5 A
INPUT FREQUENCY	50/60 Hz
EFFICIENCY	88.66% at full load
DIMENSIONS (L x W x H)	140 x 150 x 86 mm
MODULAR	Full-modular
CERTIFICATIONS	80 PLUS Gold
PFC	Active PFC
FAN SIZE	120 mm FDB
PROTECTIONS	UVP, OVP, OPP, SCP, OCP, OTP
REGULATORY	CE/FCC/C-Tik/RoHS/CCC/cTUVus/IEC/EAC
MTBF	100,000 hours
CIRCUIT STRUCTURE	LLC + DC - DC
WARRANTY	10 years

DC OUTPUT	MAX LOAD (A)	MAX OUTPUT (W)
+3.3V	20	120
+5V	20	
+12V	62.5	750
+5VSb	3	15
-12V	0.3	3.6



POWER SUPPLY  
HA-750BA4  
NGDP 750W

# SPECIFICATIONS HA-850BA4

NGDP GOLD 850W

MODEL	HA-850BA4
POWER OUTPUT	850 W
INPUT VOLTAGE	100 - 240V
INPUT CURRENT	10 - 5 A
INPUT FREQUENCY	50/60 Hz
EFFICIENCY	88.39% at full load
DIMENSIONS (L x W x H)	140 x 150 x 86 mm
MODULAR	Full-modular
CERTIFICATIONS	80 PLUS Gold
PFC	Active PFC
FAN SIZE	120 mm FDB
PROTECTIONS	UVP, OVP, OPP, SCP, OCP, OTP
REGULATORY	CE/FCC/C-Tik/RoHS/CCC/cTUVus/IEC/EAC
MTBF	100,000 hours
CIRCUIT STRUCTURE	LLC + DC - DC
WARRANTY	10 years

DC OUTPUT	MAX LOAD (A)	MAX OUTPUT (W)
+3.3V	20	120
+5V	20	
+12V	70.8	849.6
+5VSb	3	15
-12V	0.3	3.6



POWER SUPPLY  
HA-850BA4  
NGDP 850W

# SPECIFICATIONS HA-1000BA4

NGDP GOLD 1000W







MODEL	HA-1000BA4
POWER OUTPUT	1000 W
INPUT VOLTAGE	100 - 240V
INPUT CURRENT	12 - 6 A
INPUT FREQUENCY	50/60 Hz
EFFICIENCY	88.7% at full load
DIMENSIONS (L x W x H)	140 x 150 x 86 mm
MODULAR	Full-modular
CERTIFICATIONS	80 PLUS Gold
PFC	Active PFC
FAN SIZE	120 mm FDB
PROTECTIONS	UVP, OVP, OPP, SCP, OCP, OTP
REGULATORY	CE/FCC/C-Tik/RoHS/CCC/cTUVus/IEC/EAC
MTBF	100,000 hours
CIRCUIT STRUCTURE	LLC + DC - DC
WARRANTY	10 years

DC OUTPUT	MAX LOAD (A)	MAX OUTPUT (W)
+3.3V	20	120
+5V	20	
+12V	83	996
+5VSb	3	15
-12V	0.3	3.6

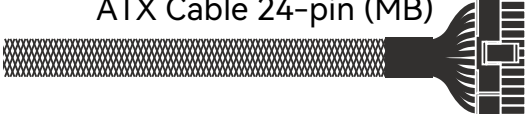

POWER SUPPLY  
HA-1000BA4  
NGDP 1000W

# CABLE INFORMATION

CONNECTORS	TOTAL LENGTH	QUANTITY
ATX Cable 24-pin (MB) 	610 mm	1
ATX12V Cable 8-pin ( CPU 4+4) 	650 mm	2
PCI-E Cable 12V-2x6 (GPU 12+4) 	720 mm	1
PCI-E Cable 8-pin ( GPU 6+2) 	600 mm	3
SATA Cable (SSD/HDD) 	465 mm	2
MOLEX Cable (4 PATA) 	465 mm	1



POWER SUPPLY  
NGDP GOLD

# INSTALLATION GUIDE

**Before You Begin, ensure your system is powered off and unplugged from any power source.**

## **Step 1: Removing the Existing PSU (Skip if building a new system)**

1. Unplug the AC power cord from both the wall outlet and the current PSU.
2. Carefully disconnect all power cables from your components (GPU, motherboard, drives, etc.).
3. Remove the old PSU from your case following your chassis manual instructions.

## **Step 2: Installing Your New PSU**

1. Verify the PSU's AC power cable is disconnected.
2. Mount the new PSU in your case using the provided screws.
3. Connect the main power cables:
  - Attach the 24-pin ATX cable to your motherboard.
  - Connect the CPU power cable (4-pin, 8-pin, or 4+4-pin) as required by your motherboard.
4. Connect component power cables:
  - SATA power cables to SSDs, HDDs, and optical drives.
  - PCIe or 12V-2x6 power cables to your graphics card(s) if needed.
  - Peripheral (Molex) cables to any components requiring them.
5. Double-check all connections are secure.
6. Organize cables for optimal airflow, using cable management features in your case.
7. Connect the AC power cord to the PSU, but don't plug it into the wall yet.

### **Important Notes:**

- Use only the cables provided with your new PSU to ensure compatibility and safety.
- Refer to your motherboard and GPU manuals for specific power requirements.
- Store unused modular cables safely for future upgrades.

**After installation, ensure all components are properly connected before powering on your system.**



# INSTALLATION GUIDE

For proper installation, match each cable connector to the same color port on the power supply unit and PC components.

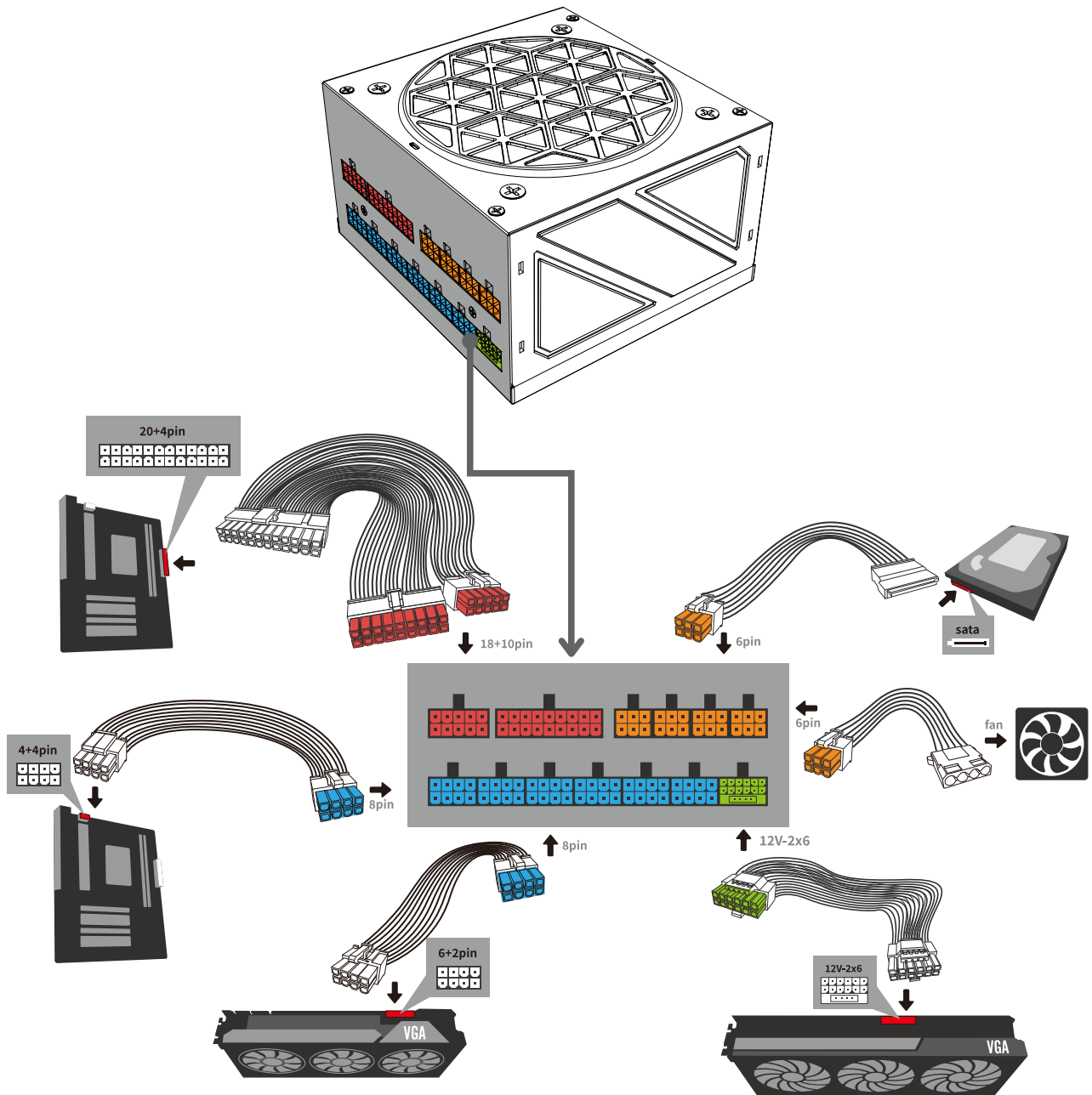

POWER SUPPLY  
NGDP GOLD