

MOTO-C

1STPLAYER GAMING DESK

**Single motor,
electric-height
adjustable table top**

Model: MOTO-C 1260
MOTO-C 1460



Version 1.0

Edited by Fan
2023.01.10



EDITED BY 1STPLAYER

MOTO-C 1260

Dimensions(L*W*H)	Product: 120*60*(72-117)cm Package: 77*74*13.5cm
Desktop	2pcs(splicing)
Materials	Metal+Steel+ABS+P2PB
Color	Tabletop: Black Table Legs: Black
CBM	0.077M ³
Loading Capacity	360pcs/20'GP, 880pcs/40'HQ
Max Capacity	60KG
Weight	N.W.: 22.0KG G.W.: 23.5KG
Certification	CE/FCC/RoHS/EN527
Features	<ol style="list-style-type: none">1.High cost performance, stable and solid structure;2.Single motor, load 60kg, after 10,000 times lifting test, safe and secure;3.72-117 cm electric lift height adjustable table top;4.With headphone hook & cup holder & cable clip;5.Intelligent height memory;6.Overload protection;7.Overheat protection;8.One-button restoration;9.Equip with cable management compartment;10.2 pieces of splicing P2PB carbon fiber board;11.Full desktop cover gaming mouse pad(120*60cm);12.Environmentally friendly material packaging;13.2 years warranty.



**GAMING DESK
MOTO-C 1260**

EDITED BY 1STPLAYER

MOTO-C 1260

120*60cm Full Desktop Cover
Gaming Mouse Pad



**GAMING DESK
MOTO-C 1260**

EDITED BY 1STPLAYER



MOTO-C 1260

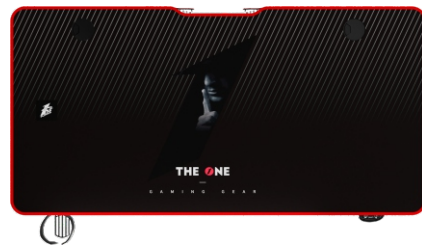
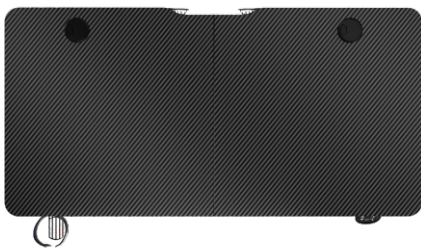

**GAMING DESK
MOTO-C 1260**

EDITED BY 1STPLAYER

MOTO-C 1460

Dimensions(L*W*H)	Product: 140*60*(72-117)cm Package: 78.5*74*13.5cm
Desktop	2pcs(splicing)
Materials	Metal+Steel+ABS+P2PB
Color	Tabletop: Black Table Legs: Black
CBM	0.079M ³
Loading Capacity	350pcs/20'GP, 860pcs/40'HQ
Max Capacity	60KG
Weight	N.W.: 23.0KG G.W.: 24.5KG
Certification	CE/FCC/RoHS/EN527
Features	<ol style="list-style-type: none">1.High cost performance, stable and solid structure;2.Single motor, load 60kg, after 10,000 times lifting test, safe and secure;3.72-117 cm electric lift height adjustable table top;4.With headphone hook & cup holder & cable clip;5.Intelligent height memory;6.Overload protection;7.Overheat protection;8.One-button restoration;9.Equip with cable management compartment;10.2 pieces of splicing P2PB carbon fiber board;11.Full desktop cover gaming mouse pad(140*60cm);12.Environmentally friendly material packaging;13.2 years warranty.



**GAMING DESK
MOTO-C 1460**

EDITED BY 1STPLAYER

MOTO-C 1460



**GAMING DESK
MOTO-C 1460**

EDITED BY 1STPLAYER

MOTO-C 1460

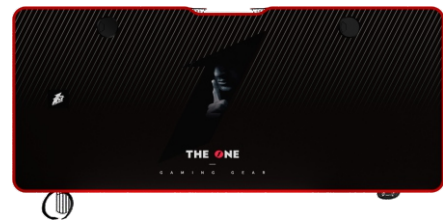

GAMING DESK
MOTO-C 1460

EDITED BY 1STPLAYER

COMPARISONS

MOTO-E

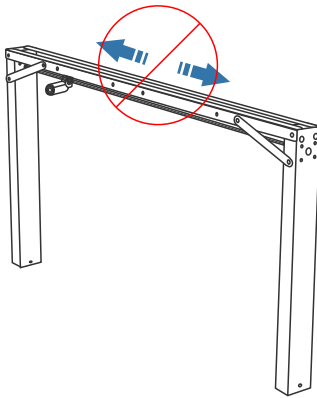

Regular desk frame, fixed length

MOTO-C

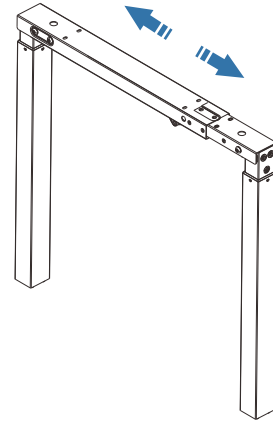

Desk frame with retractable length
reduces the volume of out box
and increases the qty of containers

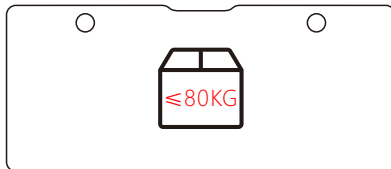

Maximum load bearing
of desktop: 80kg

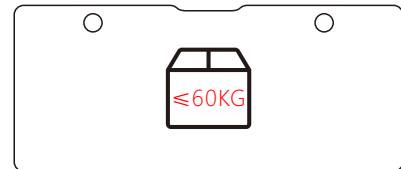

Maximum load bearing
of desktop: 60kg



**GAMING DESK
MOTO-C**

EDITED BY 1STPLAYER

COMPARISONS

MOTO-E



Foot: aluminum alloy material

MOTO-C



Foot: metal material



Gaming mouse pad
Size: 70*60CM



Full desktop gaming mouse pad
Size: 120*60/140*60CM



GAMING DESK
MOTO-C

EDITED BY 1STPLAYER

COMPARISONS

MOTO-E



Single motor, Power: 58W

MOTO-C

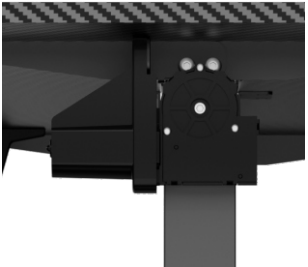

Single motor, Power: 24W

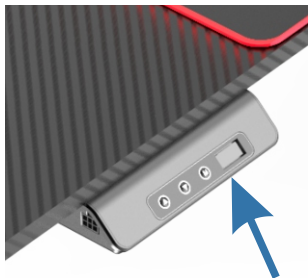

The controller screen displays the desktop height



Easier to set the standing/sitting height



GAMING DESK
MOTO-C

EDITED BY 1STPLAYER